

COUGAR® TRUCK VIBRATORS

Mobile Vibration Solutions



If only it were as easy as pushing a button . . . **NOW IT IS**



When wet, sticky, or frozen material clinging to your dump vehicle is the problem, Applied Conveyor Technology, Inc. has the solution.

ACT is your local and competitive source for compact and lightweight truck vibrators manufactured by Martin Engineering / Cougar Vibration. Cougar's complete line of rugged, durable Truck Vibrators are tightly sealed against dirt, dust, and water for long life in extreme conditions.

Shielded, oversized, permanently lubricated ball bearings assure exceptional service life. High-speed, low-amp electric motors keep size and weight to a minimum for easy, low-cost installation. And Cougar Truck Vibrators bolt to a mounting plate welded to the frame to maximize vibration effectiveness.

INCREASE PRODUCTIVITY - Since previously adhered material is practically eliminated, more payload can be hauled on each cycle. More material hauled means fewer cycles to move a given amount of material. That translates to lower labor and fuel costs, and reduced vehicle wear. With Cougar vibrators, dump times are also faster, and material is more evenly distributed when spreading. Labor costs may be further reduced since the need for an employee to clean out truck beds may be completely eliminated.

REDUCE COMMON CAUSES OF EQUIPMENT DAMAGE - Extra strain on hydraulic components from lowering half-full beds is eliminated. Operators won't need to bang the tailgate to loosen material. Drivers don't need to slam the brakes or "pop" the clutch to loosen the load minimizing the potential for damaging critical components. And there's no need to clean out the bed with a backhoe or other equipment that can scar the bed and create even more places for material to stick.

REDUCE RISKS ASSOCIATED WITH DUMPING & SPREADING COHESIVE MATERIALS - Cougar Truck Vibrators help keep the operator inside the cab and off the back of the truck. Truck vibrators can also facilitate material flow to minimize possible "tip over" during spreading or dumping.



COUGAR® DC TRUCK VIBRATOR SERIES



DC-3200/-2500-1100
1000-3200 force-lbs
at 4000-5000 vpm



DC1-400
410 force-lbs
at 3800 vpm



DC-80/-200
80-200 force-lbs
at 4000-4500 vpm

HYDRAULIC



NHD 110
2726 force-lbs
at 4000 vpm

PNEUMATIC PISTON







5016
2600-4100 vpm
at 40-80 psi

TURBINE

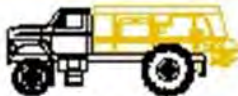
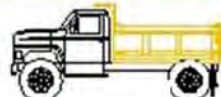

ATU-43
11700 vpm at 60 psi
13000 vpm at 80 psi

SELECTION GUIDE

Model Number	Body Length (ft)	Body Capacity	Body Style
DC-3200 HT-3200	15-40	15-30	 Tandem/Live Bottoms/ Multi-axes to 4'-0
DC-3200 DC-2700	10-15	8-16	 Rear Dump
DC-2500 DC-1600	9-10	5-10	 Rear Dump
DC-2500 DC-1600	10-15	7-10	 Spreader body
DC-1600 DC-1000	8-9	2-5	 Rear Dump
DC-1000 DC1-400	7-8	1-2	 Concrete pumps Bins/Hoppers/Chutes
DC-80	NA	1	 Spreader on pickup truck bed

Rugged and economical DC Truck Vibrators provide power to improve the speed and efficiency of unloading dump trucks and other mobile equipment. Models are available to suit your truck and your typical load.

FEATURES & BENEFITS

- Up to 3200 pounds of vibratory force to improve the unloading of wet, sticky, fibrous or even frozen material.
- Small, lightweight units require minimal space.
- Weather-proof aluminum housing provides high output to weight ratio. Sealed ball bearings eliminate lubrication requirements.
- Supplied with mounting hardware and electrical connections.
- Sealed ball bearings are permanently lubricated.

OPTIONS

- Choose from 12- or 24-volt motor; models match force to output requirements.

Installation kits are shipped standard with the DC-1000 through the DC-3200. Each "DC" installation kit includes 25' of cable (40' w/ the DC-3200), mounting plate, bolts, washers, switch, solenoid, terminals, and installation instructions. Installation kits for the DC-80 and DC1-400 include mounting bolts and washers. Circuit breakers (optional) are recommended for all "DC" vibrators. The HT-3200 installation kit includes a mounting plate, bolts, and washers.

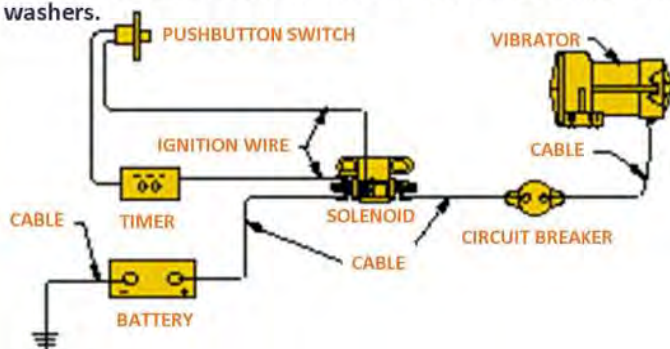

**For more information contact your
ACT Representative . . .**



Toll Free: (888)480-0680

Email: sales@groupact.com